

CATALOGUE



BELULL



One of BELULL's distinctive traits is its wish to be open, explore new ideas and innovate.

To do this, we asked well-known designers to "tame" our carbon fiber by drawing inspiration from its shape and technicity. The principle of BELULL's collections is to propose a series of limited-edition, signed furniture groups created by designers in different fields.

Though some designers have proposed pieces for us in 100% carbon, we decided to associate it with natural materials to give our own creations a soft, elegant look. Thus the wood, metal, marble or leather we use magnifies the carbon fiber and highlights its advantages.

Whether you choose a piece that is light or massive and airy or anchored to the ground, you will surely find one that is perfect for you! We hope you appreciate this furniture range as much as we do.



Our History



BELULL takes its name from the Lull family who were pioneers in the carbon fiber industry and founded Epsilon Composite, the world's leading producer of continuous profiles. Recently, they decided to diversify the company by launching a range of designer furniture using carbon fiber pieces and today they are extremely proud of their ability to preserve French manufacturing and know-how.

As part of the project, the company invited designers to highlight this semi-industrial product to validate the richness of their in-stock carbon profiles. The first collection incorporates this high-quality material by elegantly associating it with wood, metal or marble. This creative impetus has brought modernity and finesse to the company's collections. Each piece's unique character is important to BELULL and some items are proposed only in custom-made versions.

Carbon fiber



Our iconic material **We live, vibrate and think carbon fibers**

This component, an integral part of composite materials, helps offer structured pieces with exceptional mechanical properties like rigidity and resistance, even though the materials are five times lighter than metal.

While some designers have appropriated these properties by using the material on its own, we decided to associate the composite with natural materials for more finesse and elegance.

MADE IN FRANCE

Though the BELULL adventure began in the industrial world, we decided to upcycle our carbon fiber products and use our surplus production to make luxurious, refined design objects that are in keeping with the virtuous upcycling trend.

As a member of Ameublement français, we offer contemporary designer furniture that will seduce and embellish your interiors. BELULL proposes collections in limited, signed series created by designers from different horizons. The BELULL range is made up of tables, desks and consoles as well as custom-made furniture imagined for interior decoration and room layouts (headboards, bookshelves, mirrors, ...). We are thrilled to present a range that was imagined, conceived and manufactured in our French workshops.



Membre de
Ameublement français





BELULL furniture

One of BELULL's distinctive traits is its wish to be open, explore new ideas and innovate.

To do this, we asked well-known designers to "tame" our carbon fiber by drawing inspiration from its shape and technicity. The principle of BELULL's collections is to propose a series of limited-edition, signed furniture groups created by designers in different fields.



Emmanuel Gallina



Collection #1

Elegance, timelessness and simplicity are the key words that best characterize the work of Emmanuel Gallina.

He is constantly aware of line, shape and function while also paying special attention to details. After earning diplomas from E.N.A.D. in Limoges, the I.A.V. in Orleans and Politecnico in Milan, he collaborated for 7 years with Antonio Citterio on international projects before founding his own agency. Working in both Italy and France, he has collaborated with numerous brands such as Poliform, Cartier, Panasonic, Accor, Porada, AM.PM, Toulemonde Bochart and even ACRE made in Amazonia. He was chosen by Le French Design as one of the 100 top French designers.

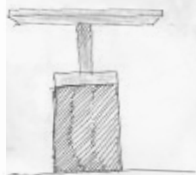

« Simplicity is complexity resolved »

Constantin Brancusi



The
Collection.

Gustave architect desk

This table is light and stylish with a hand-made base made out of carbon fiber tubes, like Gustave Eiffel's metallic structures. The table top is made out of laminated wood and carbon fiber ensuring that it is both rigid and light.

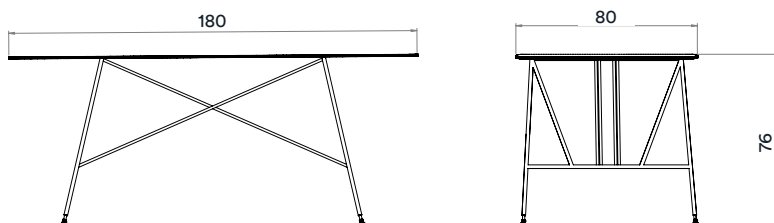

Product description.

K-PR112 (Ch)
K-PR113 (No)

Dimensions
L. 180 x W. 80 x H. 76 cm

Weight
12 kg

Materials
Oak/carbon finish, carbon base
Walnut/carbon finish, carbon base





Antoinette desk

With its sleek frame and table top with flowing lines, this half desk/half dressing table discreetly combines both functions.

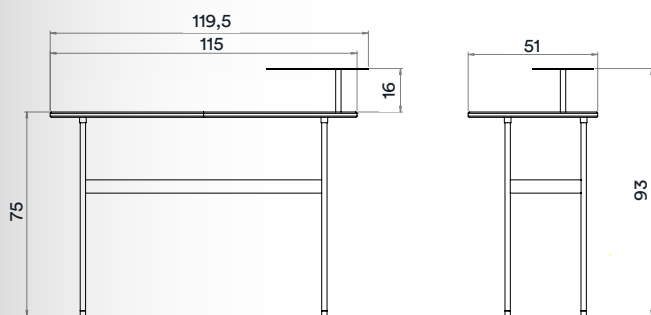

Product description.

K-PR087
K-PR114

Dimensions
L. 115 x W. 51 x H. 75 cm

Weight
21 kg

Materials
Solid oak top, carbon, carbon tablet
Solid walnut top, carbon, carbon tablet



Night table Eclipse

The Eclipse night table is sober yet refined. The accompanying, painted Terracotta tablet adds an elegant detail that will contrast with and draw attention to the noble Sahara marble top.

Product description.

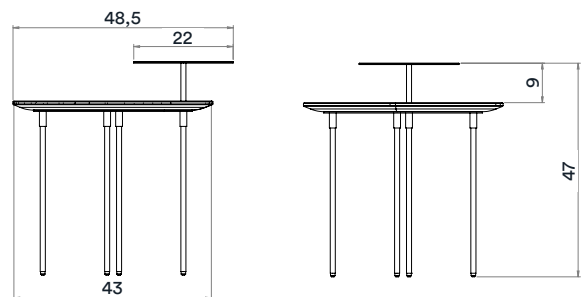

K-PR110

Dimensions
D. 43 x H. 47 cm

Weight
19 kg

Materials
Sahara marble, carbon, Terracotta steel tablet







Kumo nuage Console

Having a natural shape, the table top gives the impression of floating above the frame like a rain cloud, creating a poetic mood.

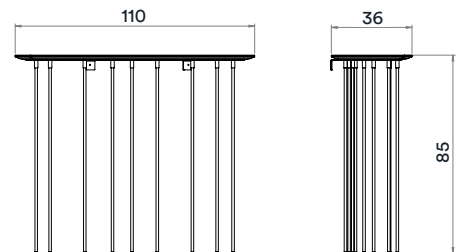

Product description.

K-PR095

Dimensions
L. 110 x W. 36 x H. 85 cm

Weight
25 kg

Materials
Carrara marble, carbon



Rotonde coffee table

With an updated Art Deco elegance, the Rotonde coffee table has an imposing, sculptural shape. Like a pedestal syncopated by its carbon sections, the bold base puts extra emphasis on the magnificent Carrara marble top. This table will give your interiors a true personality.

Product description.

K-PR096

Dimensions
D. 110 x H. 40 cm

Weight
69 kg

Materials
Carrara marble, carbon, steel

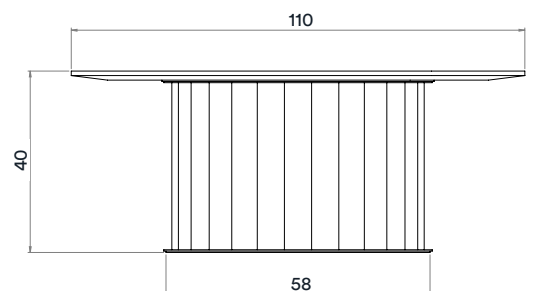



Bijoux Perle coffee table

The Bijoux tables are a precious, unique group of unusual, small tables. Symmetrical or asymmetrical games associate volume and linearity in an aesthetic where the materials work together with originality and elegance thanks to the carbon legs and marble pedestal.

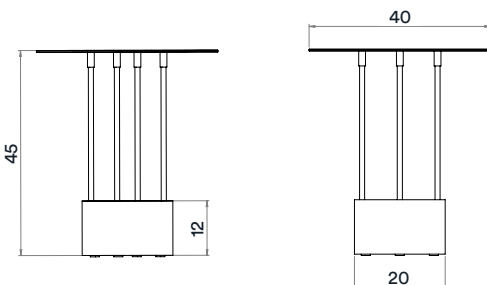

Product description.

K-PR109

Dimensions
D. 40 x H. 45 cm

Weight
15 kg

Materials
Steel 'Champagne', carbon, marble



Bijoux Diamant coffee table

The Diamant model has an oval top in champagne-colored steel.

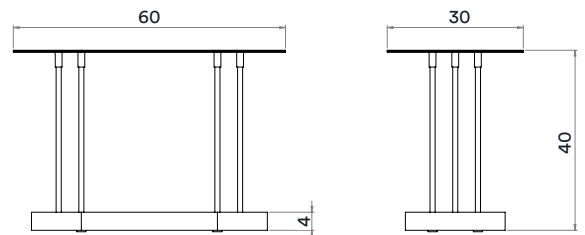

Product description.

K-PR107

Dimensions
L. 60 x W. 30 x H. 40 cm

Weight
30 kg

Materials
Steel 'Champagne', carbon, marble

Bijoux Quartz coffee table

The Bijoux Quartz table can be an end-table for a sofa or else a night table. With discreet elegance, it will slip perfectly into your home like an elegant piece of jewelry. Its champagne-colored metal top captures and reflects light in different shades throughout the day.

The Quartz coffee table has a cylindrical carbon fiber base and a round or oblong metal top.

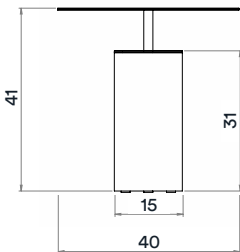

Product description.

K-PR101

Dimensions

D. 40 x H. 41 cm

Weight

7 kg

Materials

Steel 'Champagne', carbon





Bijoux Topaze coffee table

The Topaze coffee table has cylindrical carbon feet and an oblong metal top.

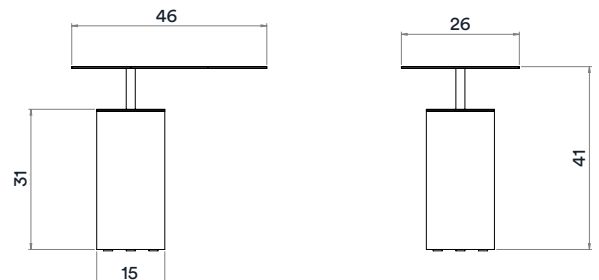

Product description.

K-PR103

Dimensions

L. 46 x W 26 x H. 41 cm

Weight

7 kg

Materials

Steel 'Champagne', carbon



Bijoux black Diamant coffee table

The black Diamant coffee table has two cylindrical carbon feet and an oblong metal top.

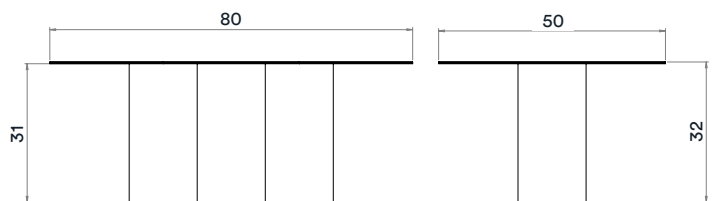

Product description.

K-PR090

Dimensions
L. 80 x W. 50 x H. 32 cm

Weight
19 kg

Materials
Steel 'Anthracite', carbon

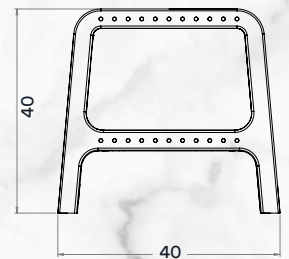

Voyage-Voyage

A beautiful object that has multiple uses as a towel rack, luggage rack or bench. It is ideal for a bedroom, bathroom or entry hall. Inspired by the luggage racks found in 1930's limousines, Voyage-Voyage updates this mythical object by reincarnating it in solid oak and carbon.

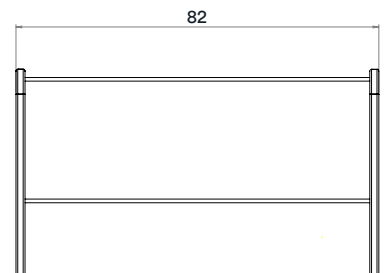

Product description.

K-PR123

Dimensions

L. 82 x W. 40 x H. 40 cm

Weight

7 kg

Materials

Solid oak, carbon







Custom made BELULL

Since each piece of furniture has a unique personality, some items are only offered in custom-made versions. Our fundamental values include listening to our clients, being available for consultations and an overall reactivity.

Each piece of furniture will find its place and perfectly integrate into your environment. Whether it is a bookshelf, a pair of closet doors or a headboard, you can choose the piece's height and width so it will fit precisely into your space.

Besides choosing the dimensions (L x W x H), you will have carte blanche to select wood finishings (different essences), colors and matte or shiny finishes for the metal pieces and the marble color ...

We offer a delivery service and at-home installation. We can also do preparatory studies.

Contact us by e-mail for a personalized offer that will be followed throughout the product's manufacture and delivery by a single person.



Pilotis Claouey table

Pilotis Claouey is a dining table from the Pilotis collection which is made up of tables in basic shapes with cylindrical legs. They are designed by Emmanuel Gallina and are reminiscent of dwellings built on stilts.

In the Carrara marble version, the carbon finish has a leather look that balances out the “minerality” of the top. In the versions with solid oak or walnut tops, the wood adds warmth and elegance to this inspired design.

The legs, finished with metallic or marble end pieces, add a final, elegant detail.



Model shown.

Dimensions

D. 140 x H. 75 cm

Weight

130 kg / 58 kg

Materials

Marble top and metal-edged legs.

Exists with either a solid oak or walnut top with marble-finished legs or metal edging at the base.



Pilotis Cabane dining room table

This table offers a great comfort due to its generous volumes. Depending on the type of chairs used, this table can seat up to 15 people. Its base is made of four cylindrical carbon fiber legs and solid oak end pieces. The table top made out of carbon fiber and wood is fine and elegant. To enjoy the warm contact with wood, we suggest you simply set the table with a table runner or placemats.

Model shown.

Dimensions

L. 400 x W. 102 x H. 75 cm

Materials

Carbon/wood finish, carbon

You can rework the dimensions, shape and finishings plus the wood veneer or other materials.







Pilotis Bassin table

The finesse of its wood-carbon top contrasts with its length. Thanks to our unique skills, we push beyond classic limits since the 27 mm thick top stands on only 4 legs. The base, with solid oak end pieces, forms a harmonious unit with the oak top. This table offers a great comfort due to its generous volumes. Depending on the type of chairs used, this table can seat up to 25 people. It weighs relatively little for a piece of this dimension and can be carried by two people.

You can rework the dimensions, shape and finishings (such as integrating and choosing the electric socket placements) plus the wood veneer or other materials.

Model shown.

Dimensions

L. 550 x W. 150 x H. 75 cm

Materials

Carbon and oak finish

You can rework the dimensions, shape and finishings plus the wood veneer or other materials.



Melanie wardrobe

The Melanie wardrobe is made up of 2 elements: the two-compartment upper storage unit holds folded linens and has a sturdy carbon rack underneath for hanging at least twenty garments like coats, blousons, dresses, pants, etc. The lower section, that can hold a suitcase, has a carbon shelf below it that is ideal for storing shoes.

Model shown

Dimensions

L. 100 x W. 35 x H. 40 cm
L. 100 x W. 35 x H. 35 cm

Materials

Solid oak, carbon





Adam & Eve Mirror

The double-sided Adam & Eve mirror will be an ideal, integral part of any room. It can define two different areas while conserving their depth and dimensions. Mounted on a pivoting shaft, it can be swiveled to capture the light or be used for your special needs and will ultimately embellish any space.

The shaft length and mirror dimensions can be adapted to harmonize with your interior.

Model shown.

Dimensions

L. 50 x H. 100 cm

Materials

Mirror, carbon



Libellule towel rack

The slim, elegant, functional, lightweight Libellule towel rack evokes a graceful dragonfly. You can choose the length and number of rods plus organize them symmetrically or stagger them based on your taste and needs.

Model shown.

Dimensions
L. 80 x p. 9 cm

Materials
Carbon



Hollywood headboard

The Hollywood headboard is extra-wide - like a movie screen - and will embellish an entire wall or part of it in your bedroom. It's "Hollywood" style adds a chic, subtle elegance to your room. And the carbon fiber's fine, discreet meshing offers extra drama. Choose between a matte or a shiny finish.

Model shown.

Dimensions

L. 250 x W. 110 cm

Materials

Carbon



Eventail closet doors

The Eventail closet doors are composed of a massive oak frame that surrounds carbon bars which can either be staggered or placed in vertical lines. The sliding doors, set on a rail, are extremely lightweight thanks to the carbon bars and will close off high spaces with an unexpected flair.

Model shown.

Dimensions

L. 260 x l. 160 cm

Materials

Carbon, massive oak



Quebec wall bookshelf

The name of the Quebec wall bookshelf evokes the wide-open spaces, endless landscapes and multiple rivers that make Quebec so charming. Its long, slim shelves give it a unique identity while its lightweight, pure lines will embellish your wall from floor to ceiling. Since it isn't bulky, it can easily fit in a narrow space to highlight your decorative items or books.

Model shown.

Dimensions

L. 300 x W. 32 x H. 26,5 cm

Materials

Carbon/wood finish, carbon



Quebec City bookshelf

The Quebec City bookshelf is a small format of the wall bookshelf with the same name. This piece will update your mezzanine, wi-fi or audiovisual area and can even define a wall niche.

Model shown.

Dimensions

L. 200 x W. 60 x H. 45 cm

Materials

Carbon/wood finish, carbon



Marcello coat rack

The Marcello coat rack is at once beautiful, massive, elegant, sober and sturdy. Easy to hang and not bulky, you can adapt it to your interior and specific needs by personalizing its dimensions and modules.

Model shown.

Dimensions

L. 56 x H. 6 x p. 2 cm

Materials

Carbon



Some realisations



Tables, desks and consoles as well as custom-made furniture imagined for your project, for interior decoration and room layouts.





GRAPHIC DESIGN

ANNE-SOPHIE ANNESE - STUDIO BOHÈME

PHOTO CREDITS

CÉCILE PERRINET-LHERMITTE, BELULL

SHOWROOM BELULL

2 rue de la corvette - 33990 Hourtin - France
+33 (0)6 42 80 46 06
b.lull@belull.com

EDITOR

EPSILON COMPOSITE
5 rue de Hourtin - 33340 Gaillan en Médoc - France
+33 (0)5 56 73 47 74

WWW.BELULL.COM



