

# ELEMENTS

Collection 2024



**BELUL**

X

ARNAUD LAPIERRE  
DESIGN & STUDIO



# Belull

BELULL specializes in designing and manufacturing limited edition furniture. Our collections, crafted by contemporary artists, embody the innovation and artistry of modern design. We are dedicated to upcycling carbon fiber parts, transforming this noble industrial material into furniture distinguished by its sleek look and stunning lines.

Our high-quality pieces are meticulously crafted in our French workshops. Visit our showroom in the south of France to explore our complete collections and immerse yourself in the unique world of BELULL.



# Our Story

## The carbon fiber - a family legacy.

BELULL derives its name from the Lull family, pioneers in the carbon fiber industry and founders of Epsilon Composite, a world leader in the production of continuous composite profiles. Proud to preserve French manufacturing and expertise, we aimed to diversify by launching a range of furniture products based on carbon parts.

As part of this project, designers are invited to highlight these semi-industrial products, infusing each piece with a unique character and creative flair.



Stéphane Lull Epsilon Composite's CEO and Bénédicte Lull BELULL's founder



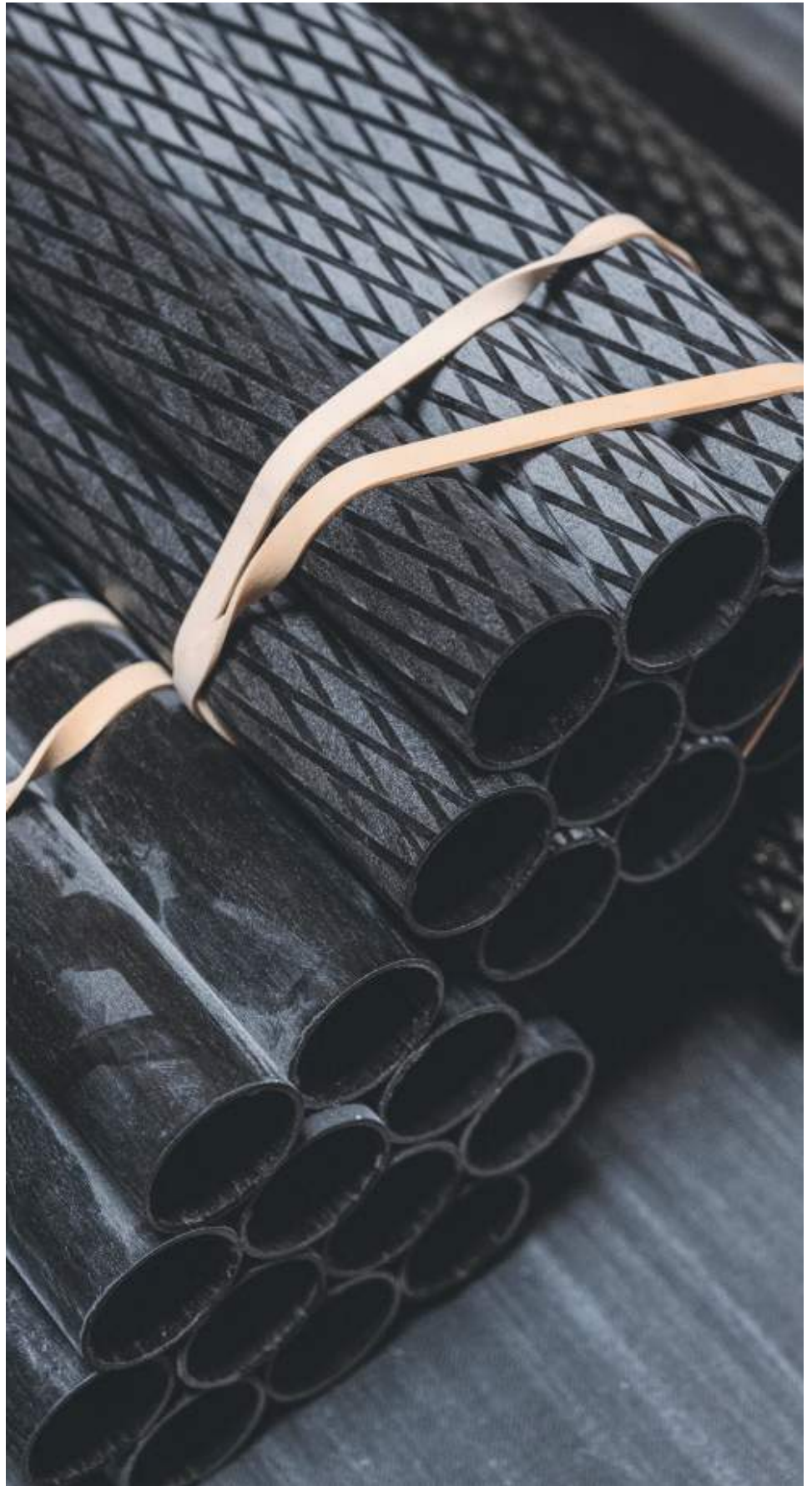

# Upcycling

## From industrial waste to artistry

Upcycling emerged from a growing concern about industrial waste. At BELULL, we aim to transform this «waste» into elegant, refined, and efficient pieces, embracing the virtuous trend of upcycling. By rethinking and reevaluating objects, we give waste new life, purpose, and use.

In just a few years, upcycling has become a major trend within the circular economy. This ethos is at the very heart of BELULL.



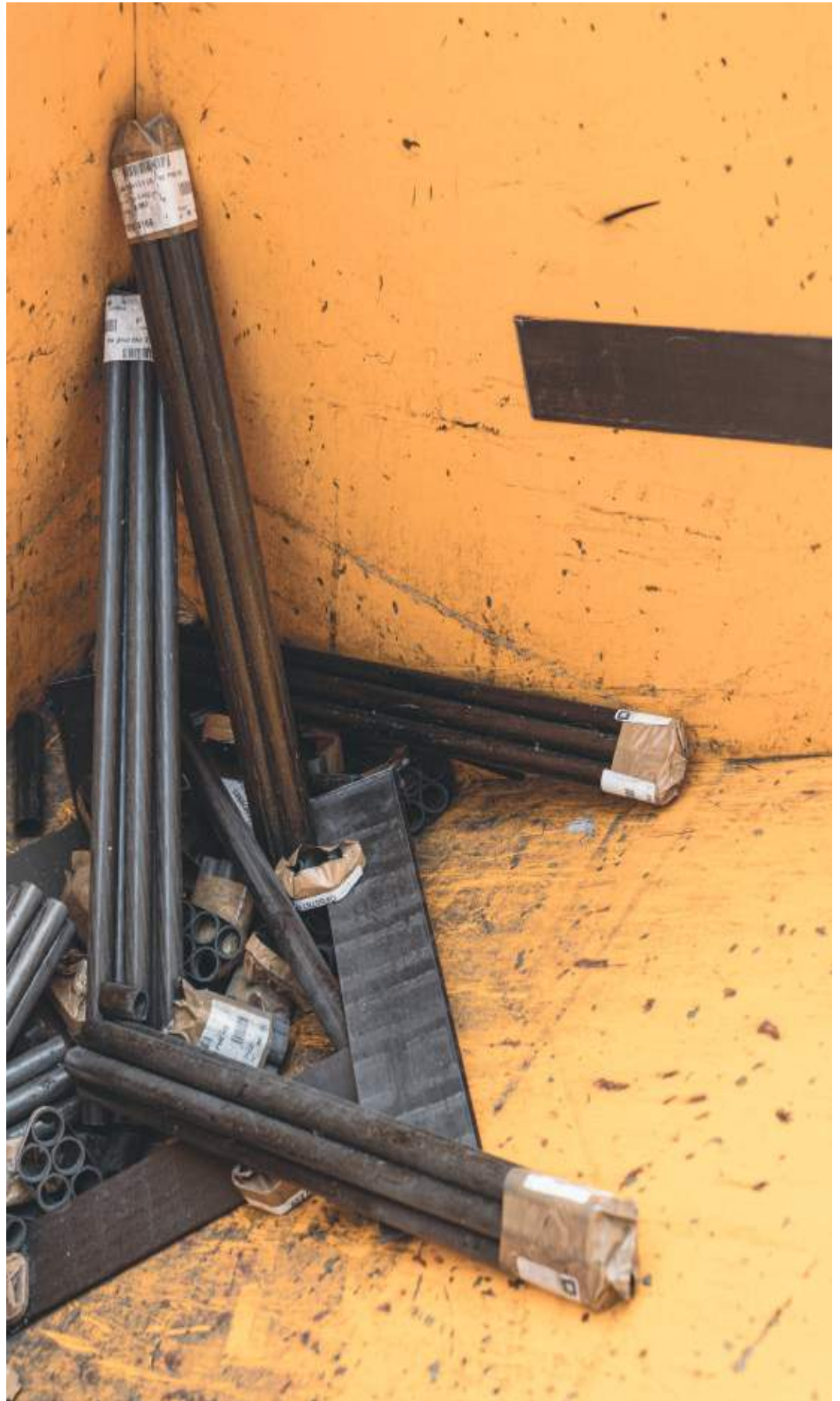

# The French Touch

## Carbon fiber : a mastery

Based in the southwest of France, Epsilon Composite is world-renowned for its carbon fiber pultrusion process and exceptional quality. BELULL's furniture is crafted in our local workshop, where our skilled artisans, leveraging their exclusive expertise, highlight the mechanical properties and aesthetics of this unique material.

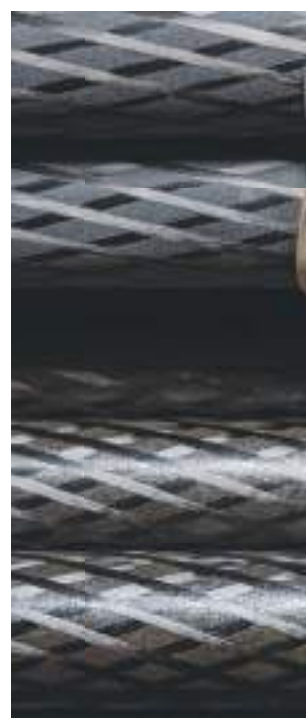





Collection

# ELEMENTS

This collection draws inspiration from the physical and chemical properties of carbon fiber tubes and plates. Arnaud Lapierre envisioned various pieces by assembling these tubes and rods, designing a collection of monochrome objects that boast an incredibly sleek and modern look.

Within the industrial world of Epsilon Composite, Arnaud Lapierre discovered the immense potential of carbon fiber. He was immediately captivated by the prospect of upcycling and eco-designing with this exclusive carbon fiber surplus, aiming to create objects made entirely of carbon fiber. For BELULL, carbon fiber is as integral as black is to the paintings of Jean Soulages.

BELULL collaborates with designers from diverse backgrounds, giving them a unique brief: to enhance, transform, and imagine objects from production excess. This stylish and eco-responsible collection includes lamps, consoles, and coffee tables, showcasing the perfect blend of elegance and sustainability.



# Arnaud Lapierre

Arnaud Lapierre Studio, a notable presence in the international design and art scene, advocates for a multidisciplinary approach to creativity. This approach spans challenges from object design to architecture, eco-design to innovation, and cognitive art to experimental installations.

The studio's collaboration with BELULL aims to anchor the brand in emotional memory. BELULL is a leading brand for carbon fiber collections, setting the standard for innovation and design in this unique material.





# T Lamp

The T Lamp is a distinctive desk lamp featuring double-sided lighting and crafted entirely from carbon fiber. Its impressive shape and volume make it a standout piece. Available in two finishes—one sandblasted and the other sanded—it offers unique textured effects, adding both visual and tactile interest.

**90% of the material used comes from industrial waste**

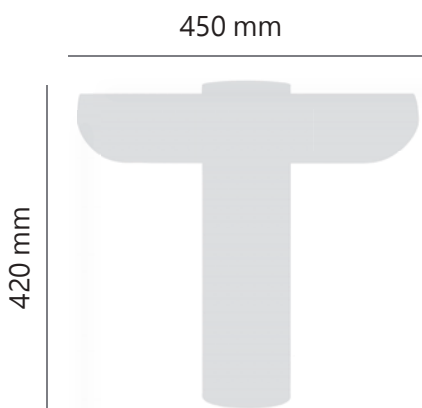



## T Lamp

The T Lamp is a distinctive desk lamp featuring double-sided lighting and crafted entirely from carbon fiber. Its impressive shape and volume make it a standout piece. Available in two finishes—one sandblasted and the other sanded—it offers unique textured effects, adding both visual and tactile interest.

**90% of the material used comes from industrial waste**

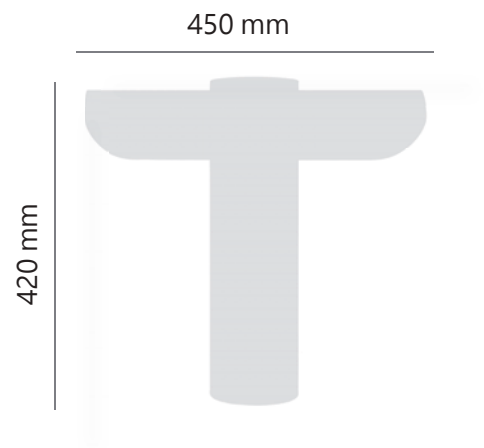











# Peel Lamp

The PEEL lamp harmoniously blends two contrasting characteristics of carbon fiber profiles to create a strong graphic identity. Its satin black carbon frame lampshade complements the base, which features carbon fiber covered with a fiberglass veil exposed to ultraviolet radiation.

This finish gives the lamp an organic appearance evocative of snake skin and a mineral quality resembling soft green moss. The table lamp is equipped with a bulb that diffuses light both downwards and upwards, enhancing both its functional and aesthetic appeal.

**90% of the material used comes from industrial waste.**

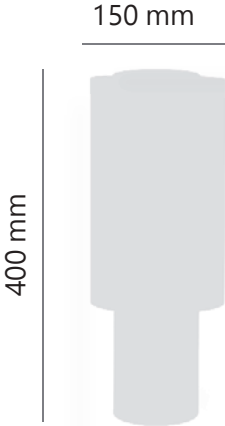



# Console Arc 70

The ARC 70 console serves as both an extra bookcase and shelf, offering versatility in usage. Its exceptionally lightweight design guarantees easy mobility.

The base, constructed from a split-profile, amplifies the distinctive character and strength of carbon fiber. The shelves are crafted from carbon plates and strengthened with carbon rods, giving the piece a luminous and striated texture.

**95% of the material used comes from industrial waste.**

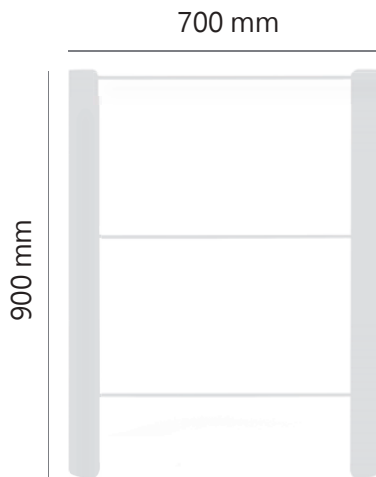



## Console Arc 80

The ARC 80 console serves as both an extra bookcase and shelf, offering versatility in usage. Its exceptionally lightweight design guarantees easy mobility.

The base, constructed from a split-profile, amplifies the distinctive character and strength of carbon fiber. The shelves are crafted from carbon plates and strengthened with carbon rods, giving the piece a luminous and striated texture.

**95% of the material used comes from industrial waste.**

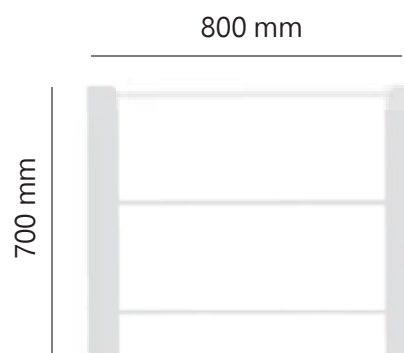











# Stripped Table

With its sleek full carbon fiber design, this table boasts a distinctive silhouette that immediately catches the eye. The STRIPPED table serves as a versatile piece, suitable as a bedside table, end table, or pedestal.

Its round top, crafted from carbon blades, incorporates a convenient induction module phone charger discreetly positioned beneath the surface. The base, a hollowed-out and ribbed carbon cylinder, offers a visually lightweight shape to the table.

**95% of the material used comes from industrial waste.**

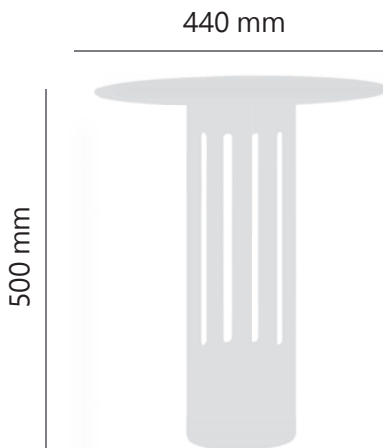



# Mosaic Table

The top features marquetry crafted from carbon plates of various geometric shapes, meticulously assembled by artisans. This intricate marquetry showcases different shades of black.

The MOSAIC table includes a wireless phone charger in its center, functioned by an induction module discreetly housed in a drawer beneath the surface.

**95% of the material used comes from industrial waste.**

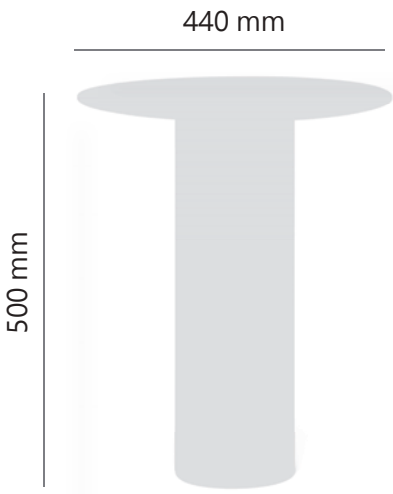
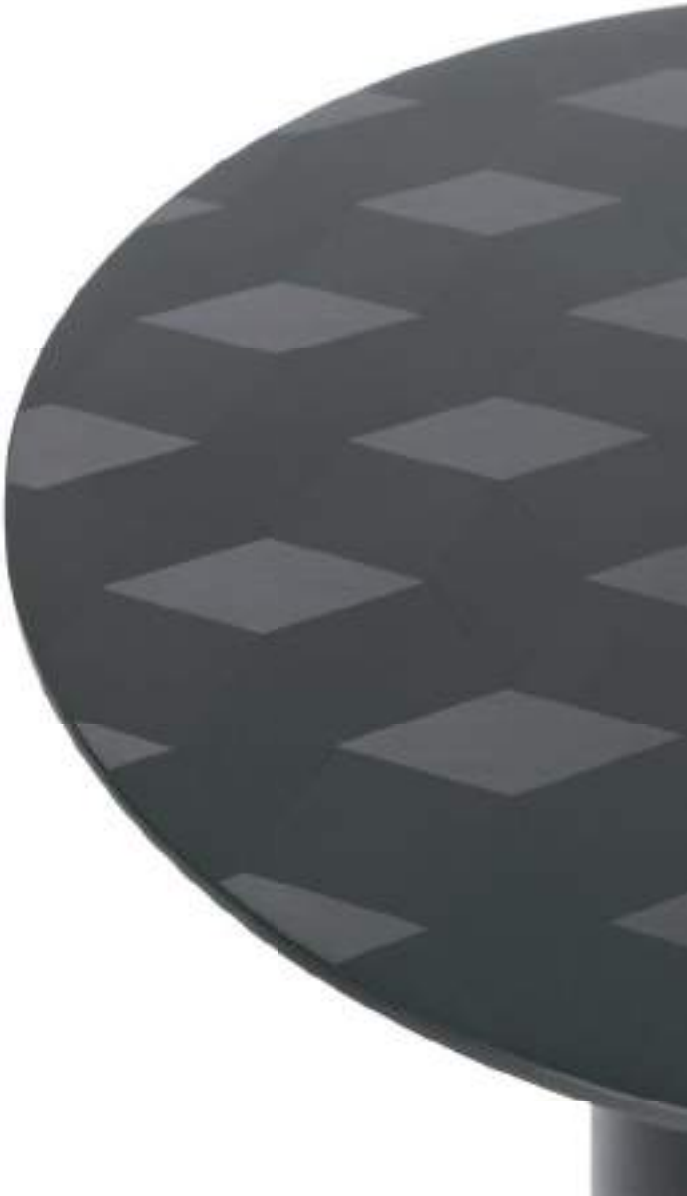







# Material library

Explore here the complete range of our furniture design materials and finishes. Within the Elements collection, our exploration of carbon fiber reveals a stunning variety of aspects and textures.

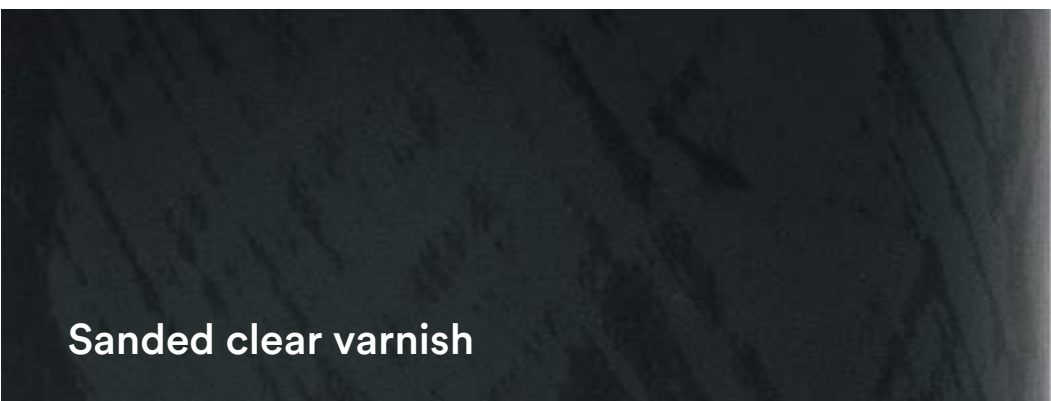
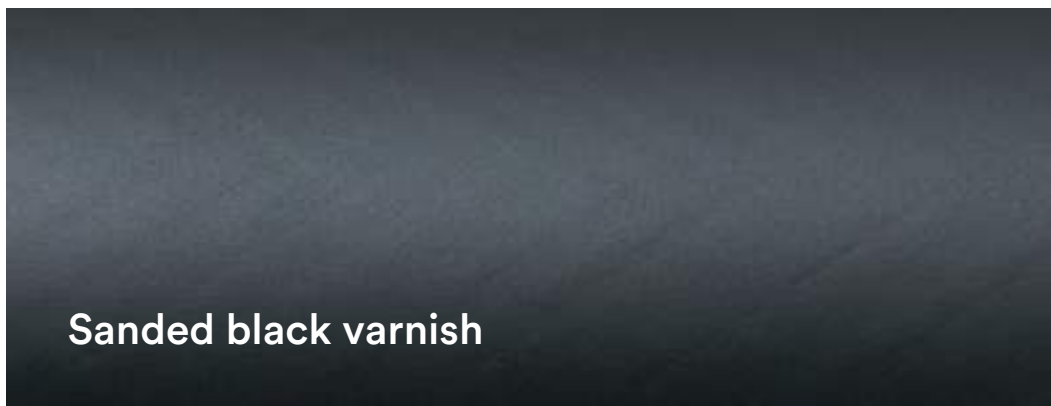

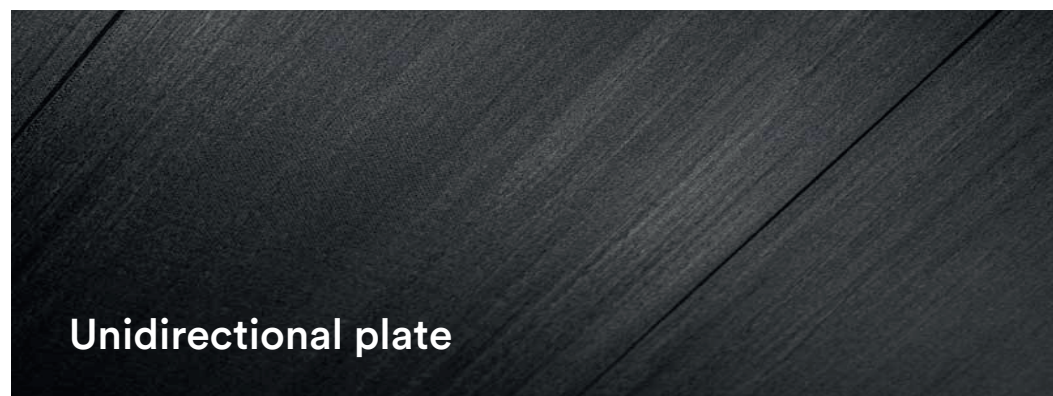
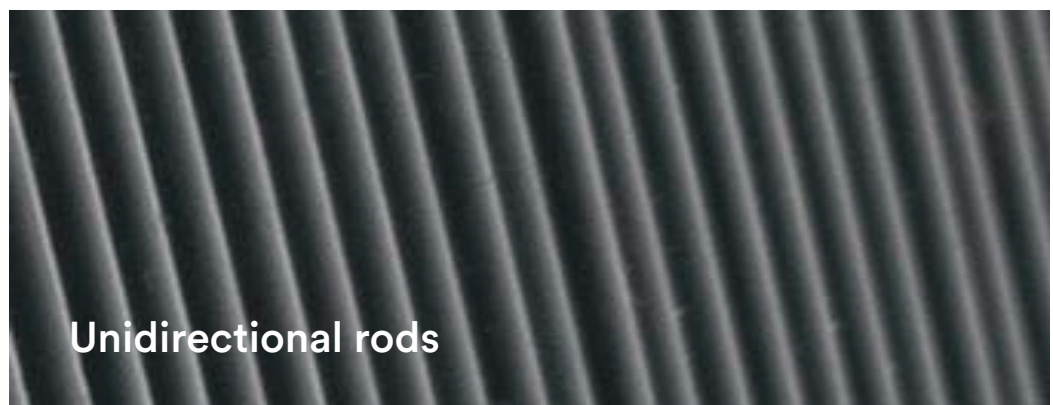
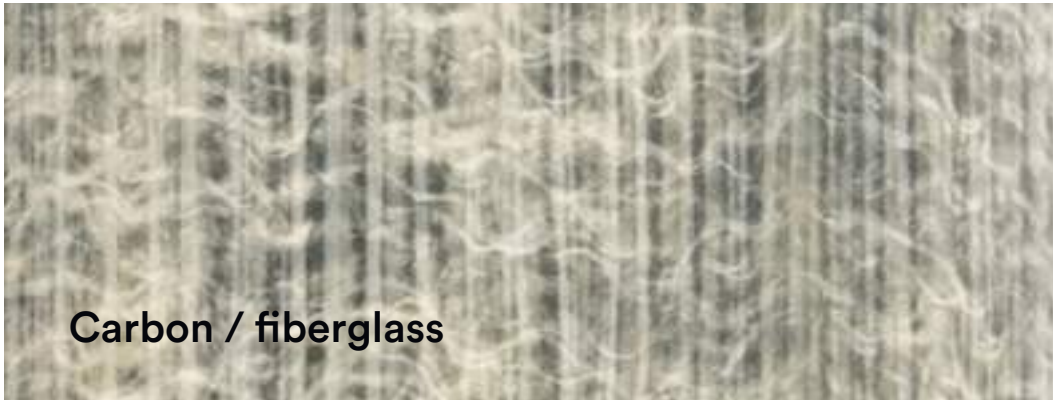

## **Graphic conception /**

BELULL

## **Photographer /**

Studio Brinth

## **BELULL showroom /**

2 rue de la corvette - 33990 Hourtin - France

+ 33 (0)6 42 80 46 06

b.lull@belull.com

## **Editing studio /**

EPSILON COMPOSITE

5 rue de hourtin - 33340 Gaillan en Médoc - France

+ 33 (0)5 56 73 47 74

b.lull@belull.com

## **Website /**

WWW.BELULL.COM

## **Instagram /**

belull\_france

## **Pinterest /**

belulldesign



